

Description

The DIODES™ AP22908 slew rate controlled load switch is a single P-channel MOSFET power switch designed for high-side load-switching applications. The MOSFET has a typical low $R_{DS(ON)}$ of 28mΩ at 3.6V, allowing increased load current handling capacity with a low forward voltage drop. The turn-on slew rate of the device is controlled internally to avoid inrush current.

The AP22908 load switch is designed to operate from 1.08V to 3.6V, making it ideal for 1.2V, 1.8V, 2.5V, 3.3V and 3.6V systems. The typical quiescent supply current is only 0.05μA.

The AP22908 is available in the wafer level chip scale 4-pin, X1-WLB0909-4 0.5mm pitch, U-WLB0909-4 0.5mm pitch, and standard SOT26 packages.

Features

- Wide Input Voltage Range: 1.08V to 3.6V
- Low On-Resistance:
 - 69mΩ Typical @1.2V
 - 41mΩ Typical @1.8V
 - 33mΩ Typical @2.5V
 - 28mΩ Typical @3.6V
- High DC Current Capability up to 1.5A
- Quick Discharging by Output Discharge Resistance
- Ultra-Low Quiescent Current 0.05μA
- Active-High Control Pin
 - Minimum 0.9V V_{IH} of ON
- ESD Protection:
 - Human Body Model: 2kV
 - Charged Device Model: 1kV
- Package:
 - X1-WLB0909-4 with Backside Laminate
 - U-WLB0909-4 with Backside Laminate
 - 0.87mm × 0.87mm, 0.5mm Ball Pitch
 - Standard Green SOT26
- Solder Ball Material: SnAgCu
- **Lead-Free Finish; RoHS Compliant (Notes 1 & 2)**
- **Halogen and Antimony Free. "Green" Device (Note 3)**
- **For automotive applications requiring specific change control (i.e. parts qualified to AEC-Q100/101/104/200, PPAP capable, and manufactured in IATF 16949 certified facilities), please [contact us](https://www.diodes.com/quality/product-definitions/) or your local Diodes representative.**

<https://www.diodes.com/quality/product-definitions/>

Notes: 1. EU Directive 2002/95/EC (RoHS), 2011/65/EU (RoHS 2) & 2015/863/EU (RoHS 3) compliant. All applicable RoHS exemptions applied.
 2. See <https://www.diodes.com/quality/lead-free/> for more information about Diodes Incorporated's definitions of Halogen- and Antimony-free, "Green" and Lead-free.
 3. Halogen- and Antimony-free "Green" products are defined as those which contain <900ppm bromine, <900ppm chlorine (<1500ppm total Br + Cl) and <1000ppm antimony compounds.

Pin Assignments

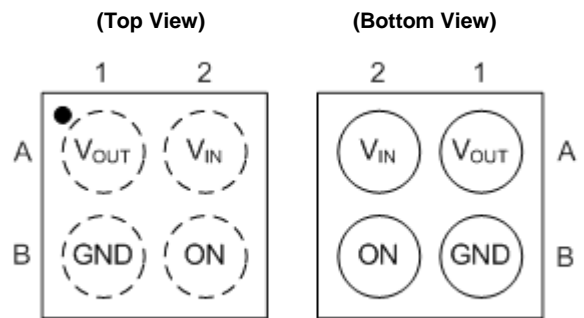

X1-WLB0909-4 & U-WLB0909-4

(Top View)

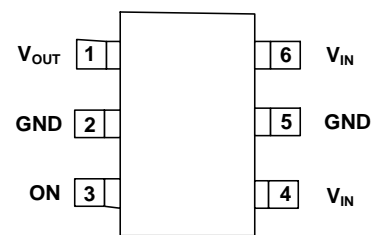

SOT26

Applications

- Mobile devices and smart phones
- Portable media devices
- Wearable devices
- Advanced notebooks, UMPC, and MID
- Portable medical devices
- GPS and navigation equipment
- Portable instrumentation

Typical Applications Circuit

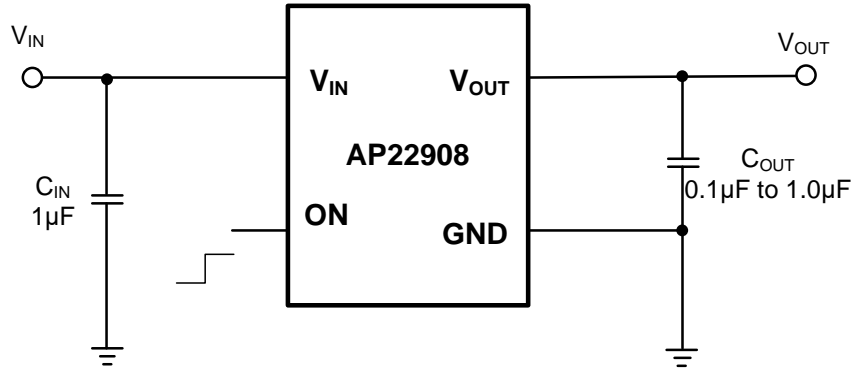

Pin Descriptions

Pin Name	Pin Number		Function
	SOT26	X1-WLB0909-4 U-WLB0909-4	
V _{OUT}	1	A1	Voltage output pin. This is the pin to the P-channel MOSFET drain connection. Bypass to ground through a 0.1µF to 1µF capacitor.
V _{IN}	4, 6	A2	Voltage input pin. This is the pin to the P-channel MOSFET source. Bypass to ground through a 1µF capacitor.
GND	2, 5	B1	Ground
ON	3	B2	Enable input, active high

Functional Block Diagram

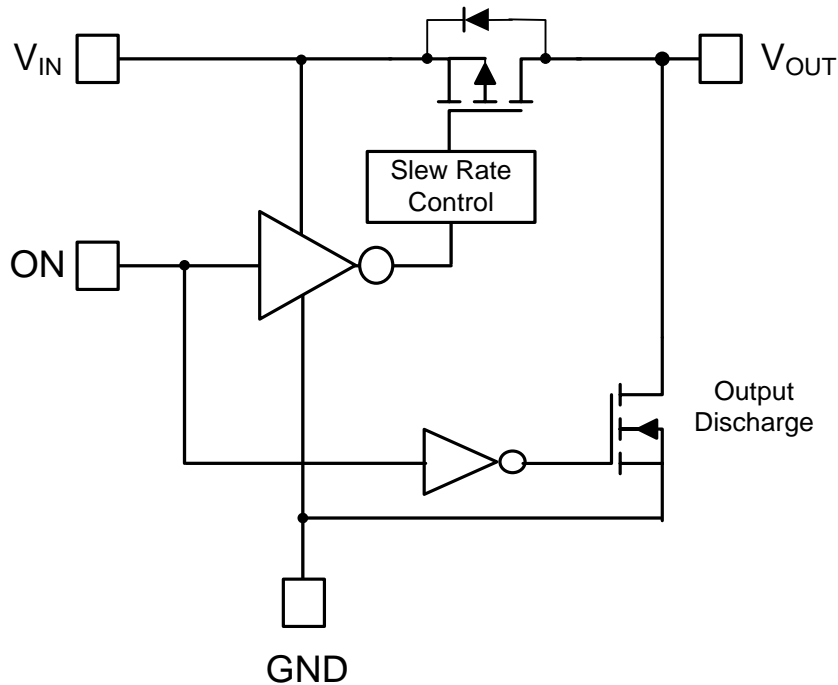

Absolute Maximum Ratings (@T_A = +25°C, unless otherwise specified.)

Symbol	Parameter	Ratings		Unit
ESD HBM	Human Body Model ESD Protection	2		kV
ESD CDM	Charged Device Model ESD Protection	1		kV
V _{IN}	Input Voltage	-0.3 to 4		V
V _{OUT}	Output Voltage	-0.3 to 4		V
V _{ON}	ON Voltage	-0.3 to 4		V
I _{OUT}	Maximum Continuous Output Current (V _{IN} ≥ 1.2V)	1.5		A
I _{OUT}	Maximum Pulse Output Current, Pulse <300µs, 2% Duty Cycle	2.5		A
T _J	Maximum Junction Temperature	-40 ~+125		°C
T _{STG}	Storage Temperature Range	-65 to +150		°C
P _D	Power Dissipation	X1-WLB0909-4 U-WLB0909-4	735	mW
		SOT26	606	mW
R _{θJA}	Thermal Resistance, Junction to Ambient (Note 4)	X1-WLB0909-4 U-WLB0909-4	136	°C/W
		SOT26	165	°C/W
R _{θJC}	Thermal Resistance, Junction to Case (Note 5)	X1-WLB0909-4 U-WLB0909-4	31	°C/W
		SOT26	30	°C/W

Notes: 4. The JEDEC high-K (2s2p) board used to derive this data was a 3 inch × 3 inch, multilayer board with 1oz internal power and ground planes with 2oz copper traces on top and bottom of the board.
5. Thermal resistance from junction to case.

Caution: Stresses greater than the 'Absolute Maximum Ratings' specified above, can cause permanent damage to the device. These are stress ratings only; functional operation of the device at these or any other conditions exceeding those indicated in this specification is not implied. Device reliability can be affected by exposure to absolute maximum rating conditions for extended periods of time.

Recommended Operating Conditions (@T_A = +25°C, unless otherwise specified.)

Symbol	Parameter	Min	Max	Unit
V _{IN}	Input Voltage	1.08	3.6	V
V _{ON}	ON Voltage Range	0	3.6	V
V _{OUT}	Output Voltage	0	3.6	V
I _{OUT}	Output Current	0	1.5	A
V _{IH}	ON High-Level Input Voltage	0.9	3.6	V
V _{IL}	ON Low-Level Input Voltage	0	0.38	V
T _A	Operating Ambient Temperature	-40	+85	°C

Electrical Characteristics ($T_A = -40^{\circ}\text{C}$ to $+85^{\circ}\text{C}$, $V_{IN} = 1.08\text{V}$ to 3.6V , $V_{ON} = V_{IN}(\text{enabled})$, $V_{ON} = 0\text{V}(\text{disabled})$, $C_{IN} = 1\mu\text{F}$, $C_{OUT} = 0.1\mu\text{F}$, typical values are at $T_A = +25^{\circ}\text{C}$, unless otherwise specified.) (Note 6)

Symbol	Parameters	Test Conditions		Min	Typ	Max	Unit
I_Q	Input Quiescent Current	$I_{OUT} = 0\text{mA}$, $V_{ON} = V_{IN}(\text{Enabled})$	$T_A = -40^{\circ}\text{C}$ to $+85^{\circ}\text{C}$	—	0.05	1	μA
I_{SHDN}	Input Shutdown Current	$R_L = 1\text{M}\Omega$, $V_{ON} = \text{Disabled}$	$T_A = -40^{\circ}\text{C}$ to $+85^{\circ}\text{C}$	—	0.04	0.5	μA
I_{IN_LEAK}	Input Leakage Current	$V_{OUT} = 0\text{V}$, $V_{ON} = \text{Disabled}$	$T_A = -40^{\circ}\text{C}$ to $+85^{\circ}\text{C}$	—	0.04	0.5	μA
I_{ON}	ON Input leakage	$V_{ON} = 1.1\text{V}$ to 3.6V or $V_{ON} = V_{IN}$	$T_A = -40^{\circ}\text{C}$ to $+85^{\circ}\text{C}$	—	0.01	0.1	μA
$R_{DS(ON)}$	X1-WLB0909-4 & U-WLB0909-4 Package, Switch On-Resistance, $I_{OUT} = -200\text{mA}$	$V_{IN} = 3.6\text{V}$	$T_A = +25^{\circ}\text{C}$	—	28	32	m Ω
			$T_A = -40^{\circ}\text{C}$ to $+85^{\circ}\text{C}$	—	—	40	
		$V_{IN} = 2.5\text{V}$	$T_A = +25^{\circ}\text{C}$	—	33	38	
			$T_A = -40^{\circ}\text{C}$ to $+85^{\circ}\text{C}$	—	—	45	
		$V_{IN} = 1.8\text{V}$	$T_A = +25^{\circ}\text{C}$	—	41	50	
			$T_A = -40^{\circ}\text{C}$ to $+85^{\circ}\text{C}$	—	—	54	
		$V_{IN} = 1.2\text{V}$	$T_A = +25^{\circ}\text{C}$	—	69	87	
			$T_A = -40^{\circ}\text{C}$ to $+85^{\circ}\text{C}$	—	—	91	
	$V_{IN} = 1.08\text{V}$	$T_A = +25^{\circ}\text{C}$	—	112	155		
		$T_A = -40^{\circ}\text{C}$ to $+85^{\circ}\text{C}$	—	—	165		
	SOT26 Package, Switch On-Resistance, $I_{OUT} = -200\text{mA}$	$V_{IN} = 3.6\text{V}$	$T_A = +25^{\circ}\text{C}$	—	40	43	m Ω
			$T_A = -40^{\circ}\text{C}$ to $+85^{\circ}\text{C}$	—	—	55	
		$V_{IN} = 2.5\text{V}$	$T_A = +25^{\circ}\text{C}$	—	45	49	
			$T_A = -40^{\circ}\text{C}$ to $+85^{\circ}\text{C}$	—	—	59	
$V_{IN} = 1.8\text{V}$		$T_A = +25^{\circ}\text{C}$	—	53	62		
		$T_A = -40^{\circ}\text{C}$ to $+85^{\circ}\text{C}$	—	—	69		
$V_{IN} = 1.2\text{V}$		$T_A = +25^{\circ}\text{C}$	—	91	110		
		$T_A = -40^{\circ}\text{C}$ to $+85^{\circ}\text{C}$	—	—	120		
$V_{IN} = 1.08\text{V}$	$T_A = +25^{\circ}\text{C}$	—	120	175			
	$T_A = -40^{\circ}\text{C}$ to $+85^{\circ}\text{C}$	—	—	185			
R_{DIS}	Discharge FET On-Resistance	$V_{IN} = 3.3\text{V}$, $V_{ON} = 0\text{V}$, $I_{OUT} = 30\text{mA}$, $T_A = +25^{\circ}\text{C}$		—	80	100	Ω

Note: 6. Specifications are over -40°C to $+85^{\circ}\text{C}$ and are guaranteed by characterization and design.

Timing Characteristics (Note 7)

Symbol	Parameters	Test Conditions	Min	Typ	Max	Unit
t_{ON}	Output Turn-On Time	$V_{IN} = 3.6V, R_L = 10\Omega, C_{OUT} = 0.1\mu F, T_A = +25^\circ C$	—	110	—	μs
t_{OFF}	Output Turn-Off Time		—	5	—	μs
t_R	Output Rise Time		—	105	—	μs
t_F	Output Fall Time		—	2	—	μs
t_{ON}	Output Turn-On Time	$V_{IN} = 1.08V, R_L = 10\Omega, C_{OUT} = 0.1\mu F, T_A = +25^\circ C$	—	900	—	μs
t_{OFF}	Output Turn-Off Time		—	5	—	μs
t_R	Output Rise Time		—	442	—	μs
t_F	Output Fall Time		—	2	—	μs

Note: 7. Rise and fall time of the control signal are less than 100ns.

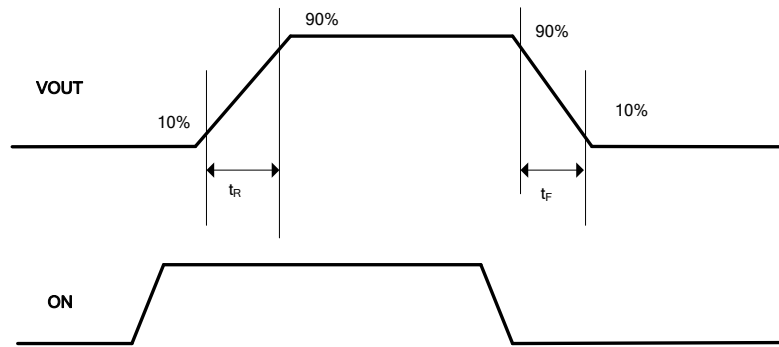

Output Rise (t_R) and Fall (t_F) Time

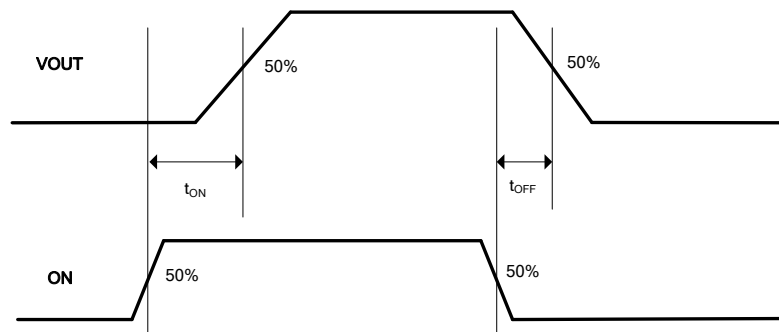

Output Turn On (t_{ON}) and Turn Off (t_{OFF}) time

Typical Performance Characteristics ($C_{IN} = 1\mu F$, $C_{OUT} = 0.1\mu F$, unless otherwise specified.)

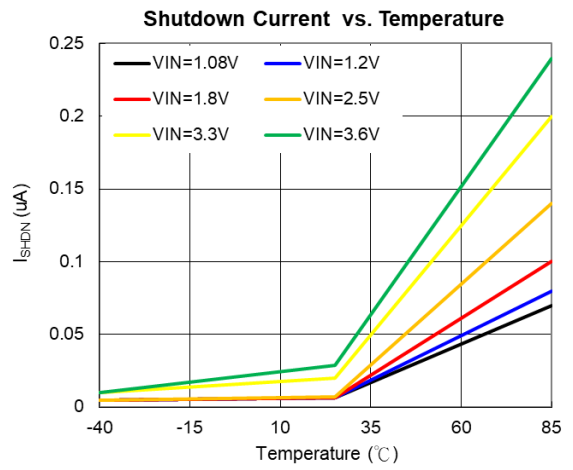
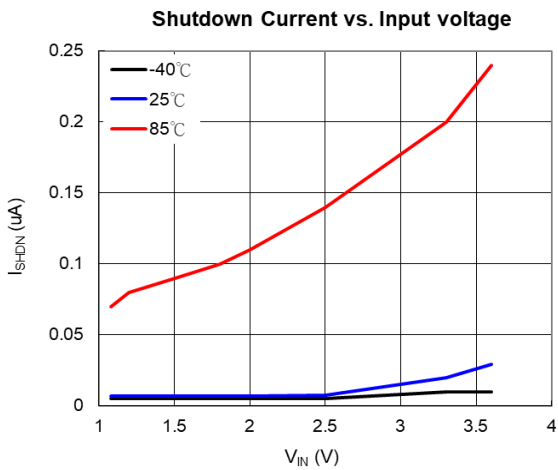
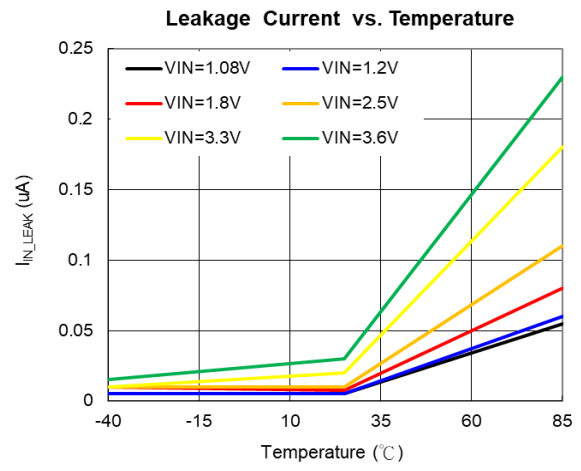
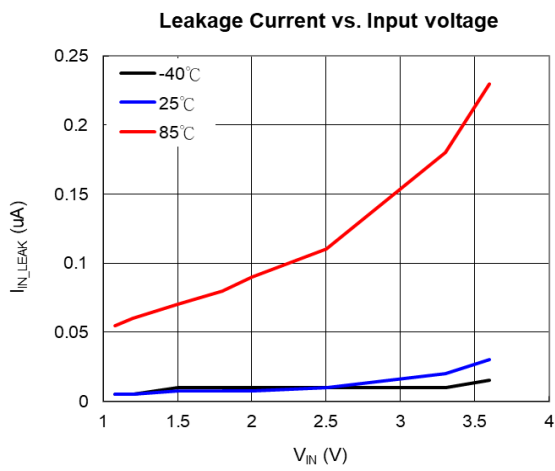
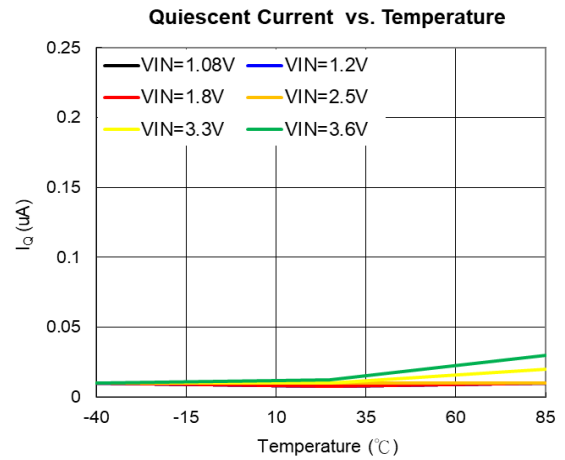
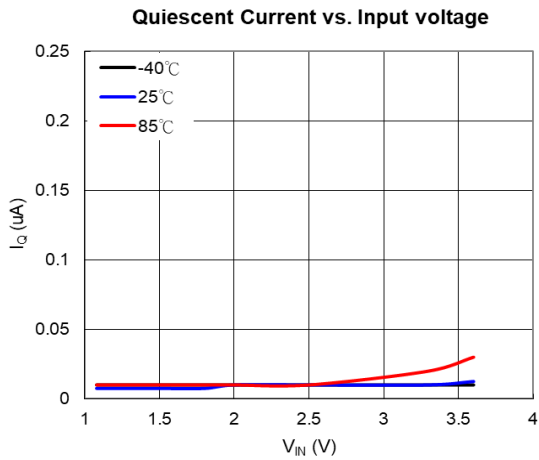

Typical Performance Characteristics ($C_{IN} = 1\mu F$, $C_{OUT} = 0.1\mu F$, unless otherwise specified.)

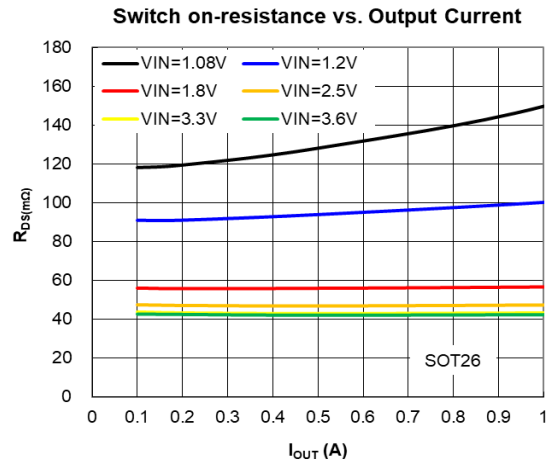
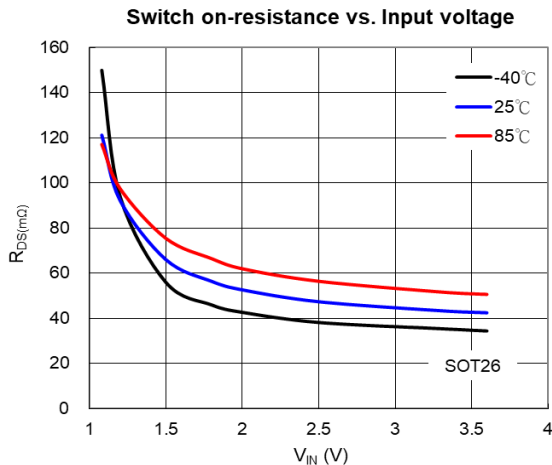
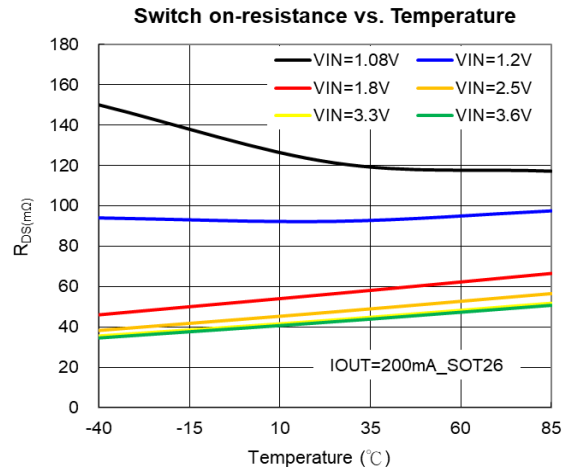
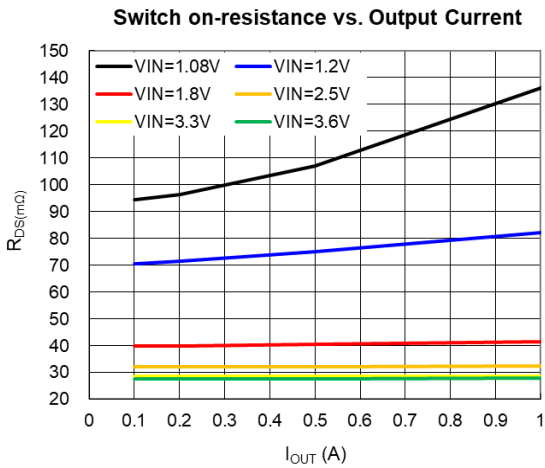
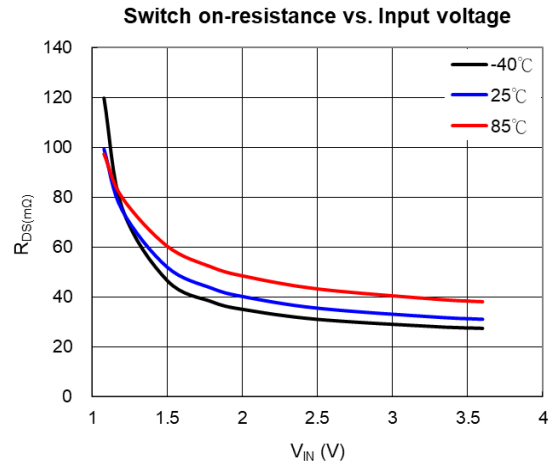
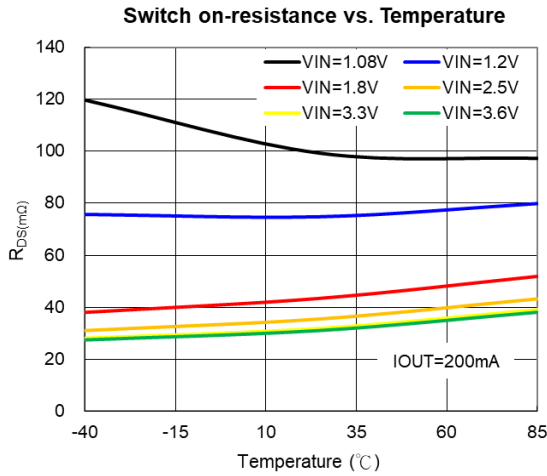

Typical Performance Characteristics ($C_{IN} = 1\mu F$, $C_{OUT} = 0.1\mu F$, unless otherwise specified.)

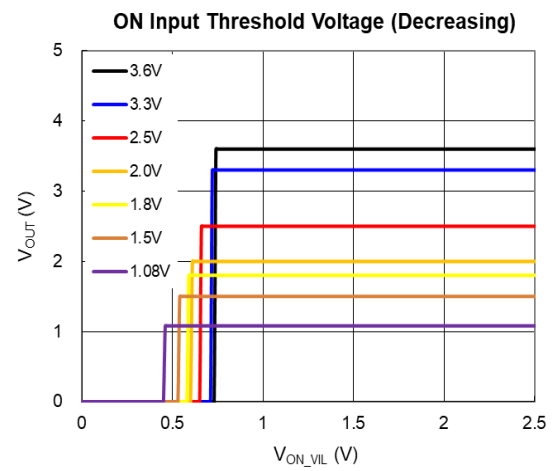
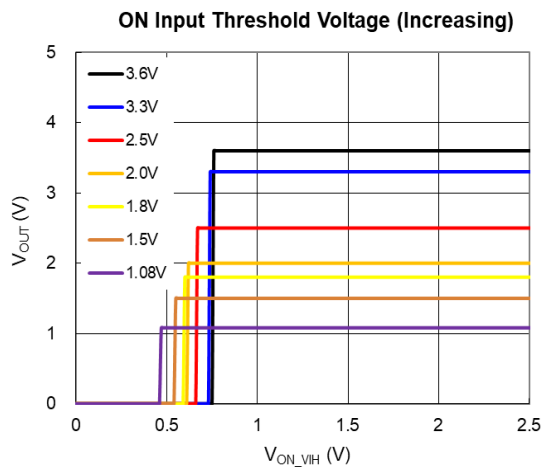
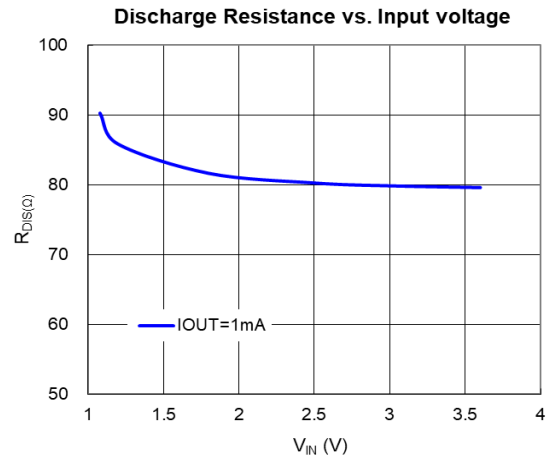
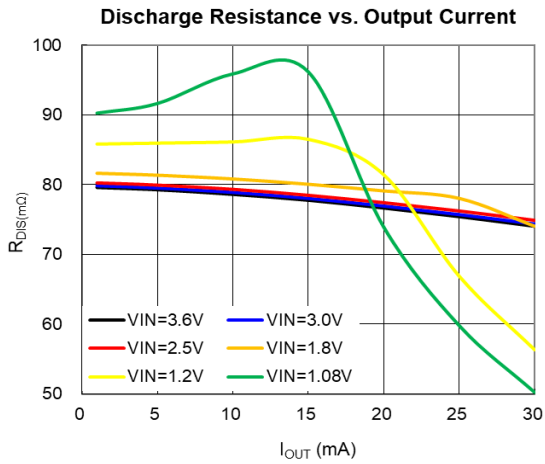

Typical Performance Characteristics ($C_{IN} = 1\mu F$, $C_{OUT} = 0.1\mu F$, $R_L = 10\Omega$, unless otherwise specified.)

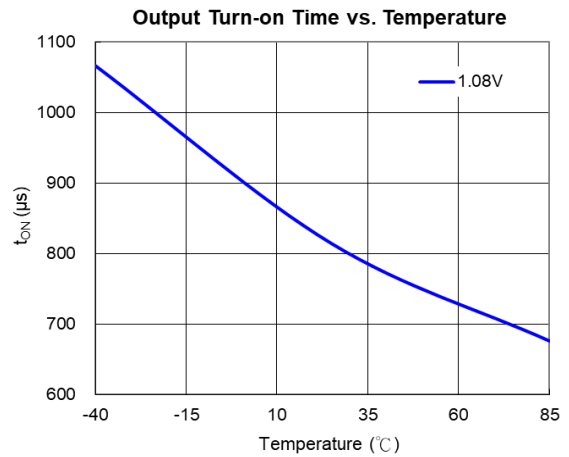
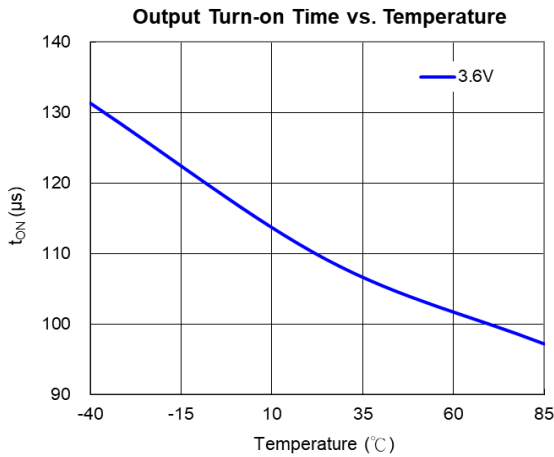
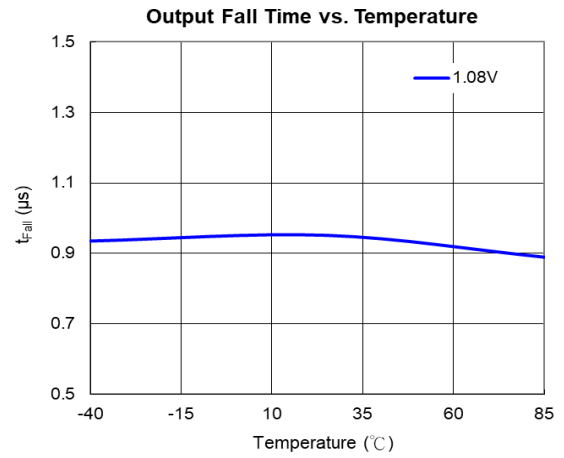
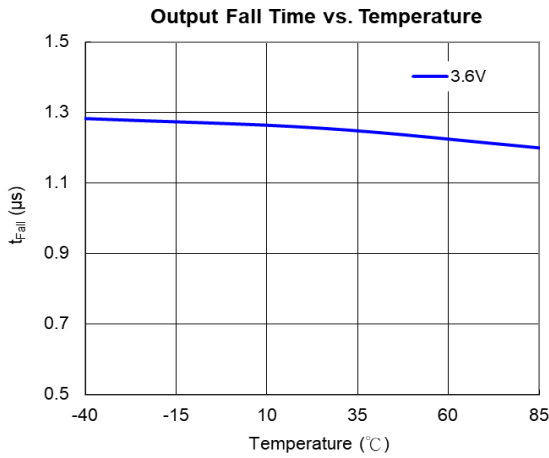
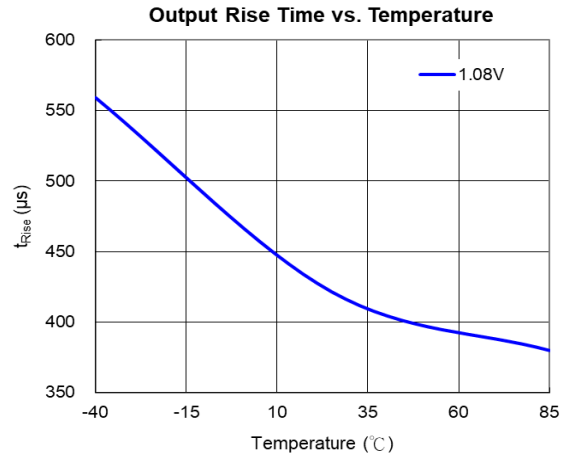
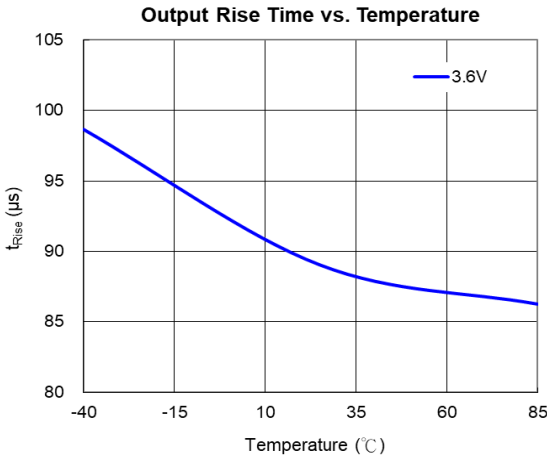

Typical Performance Characteristics ($C_{IN} = 1\mu F$, $C_{OUT} = 0.1\mu F$, $R_L = 10\Omega$, unless otherwise specified.)

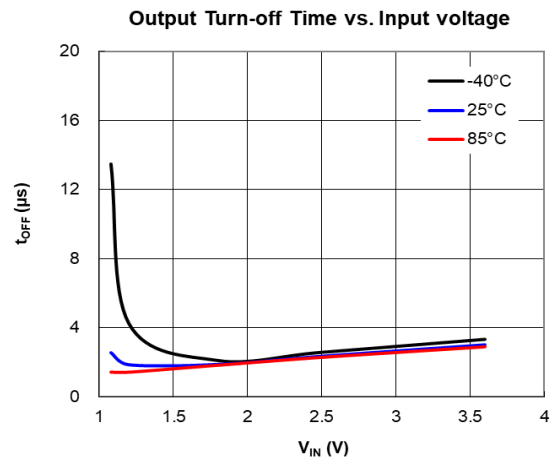
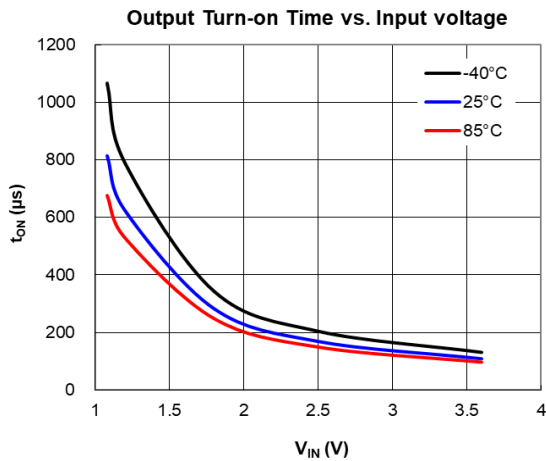
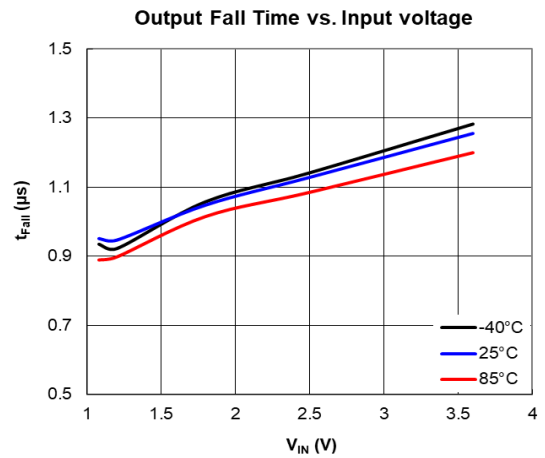
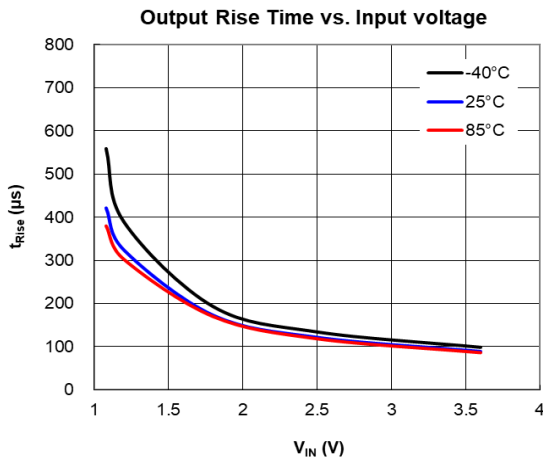
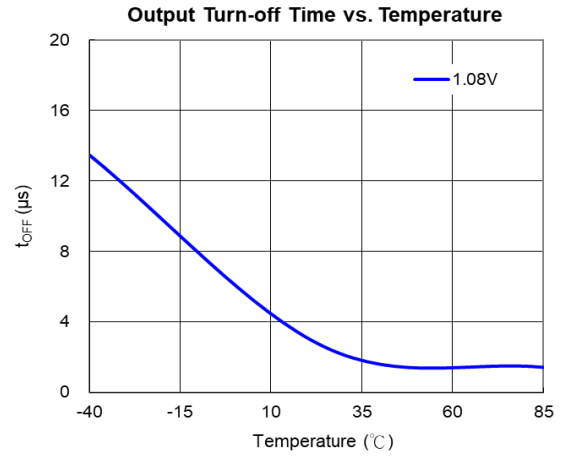
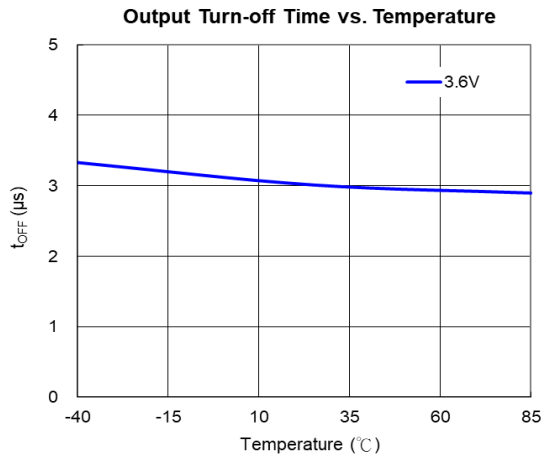

Typical Performance Characteristics ($C_{IN} = 1\mu F$, $C_{OUT} = 0.1\mu F$, $R_L = 10\Omega$, unless otherwise specified.)

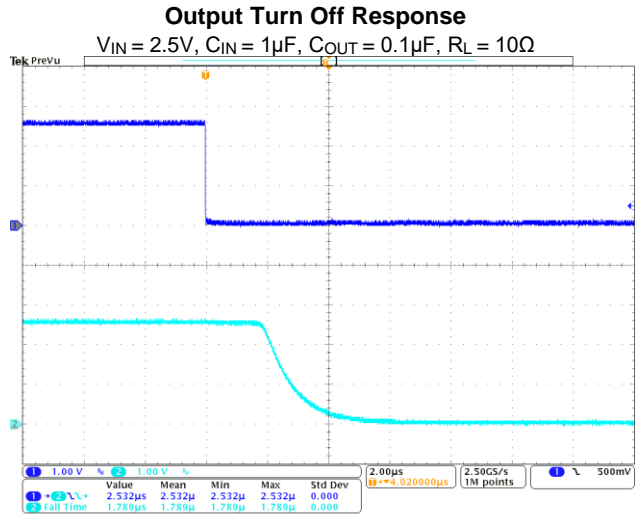
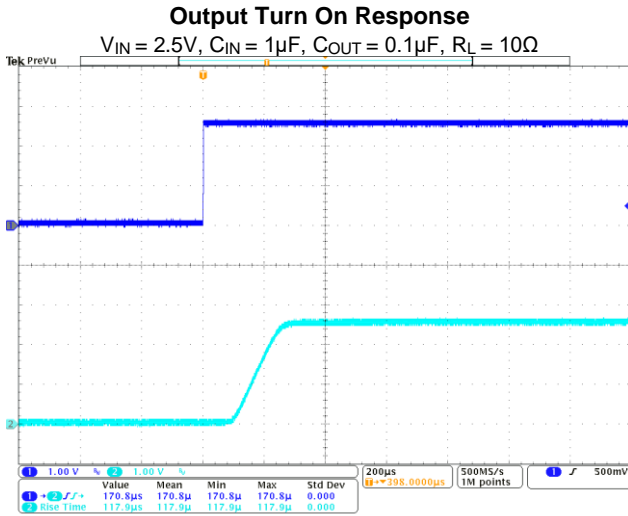
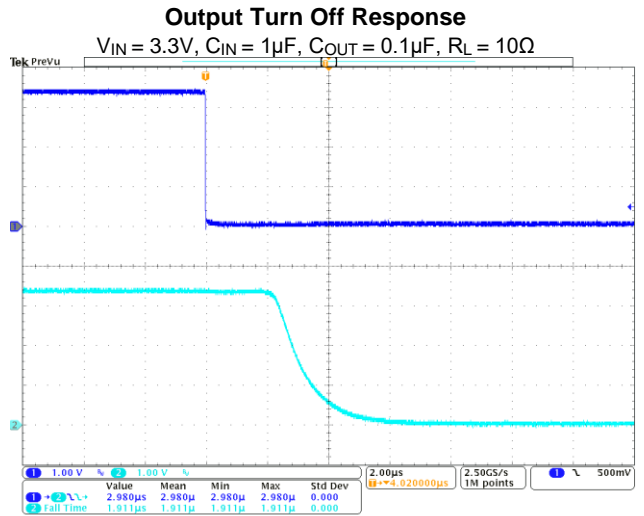
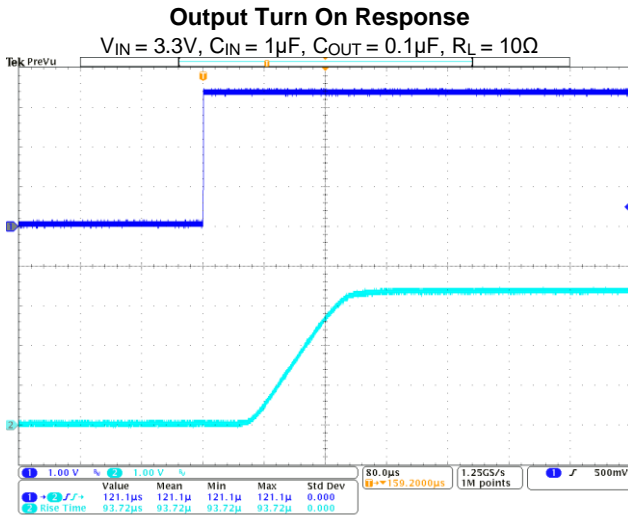
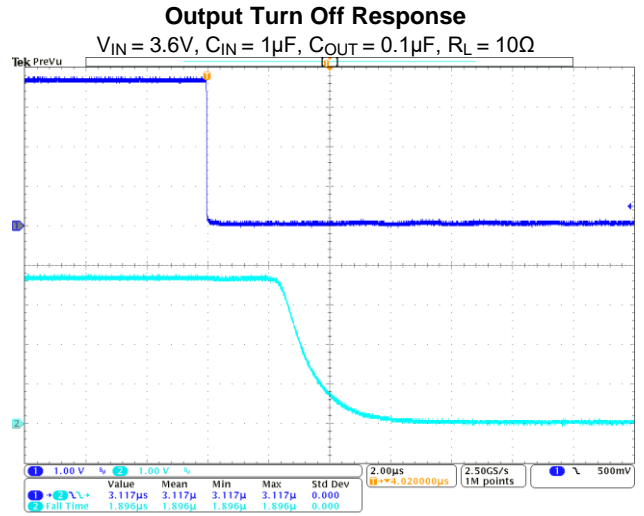
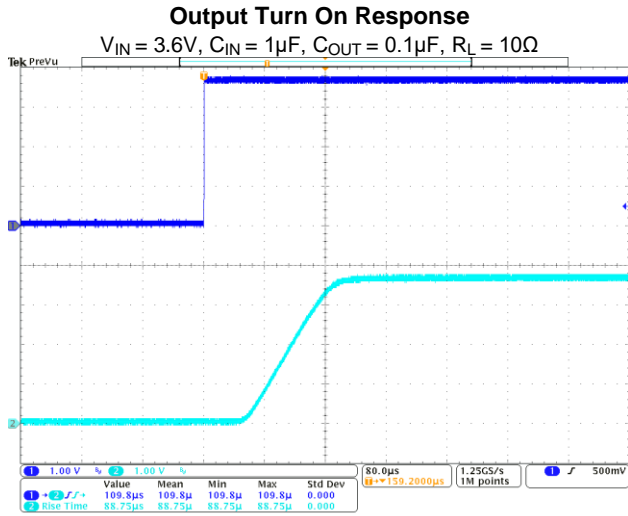

Typical Performance Characteristics ($C_{IN} = 1\mu F$, $C_{OUT} = 0.1\mu F$, $R_L = 10\Omega$, unless otherwise specified.)

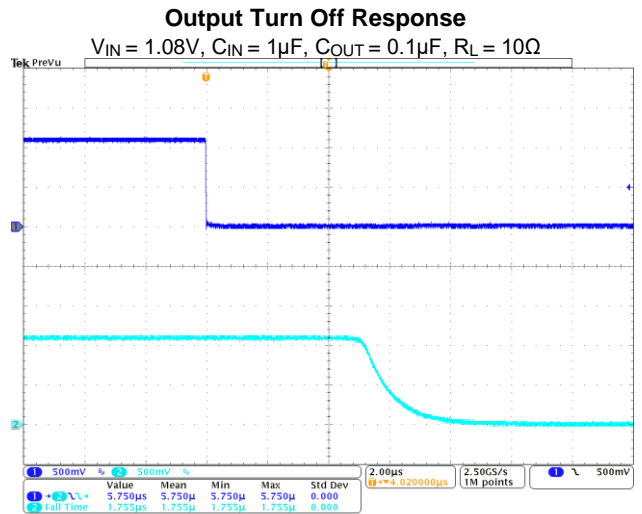
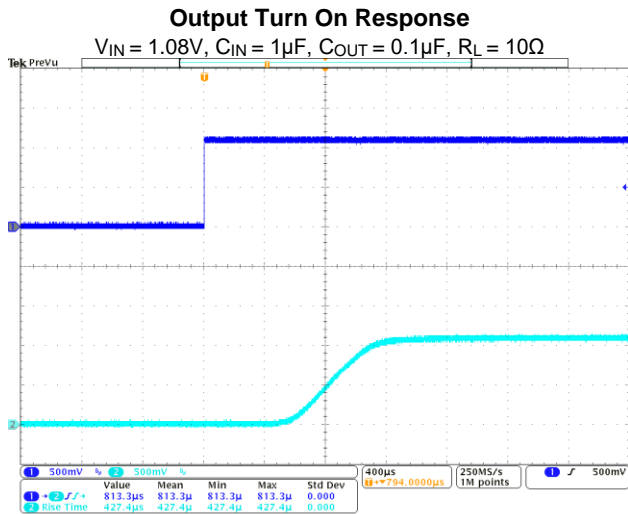
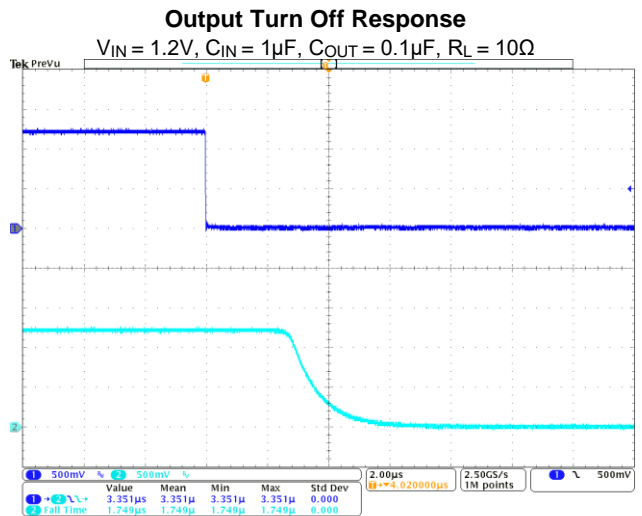
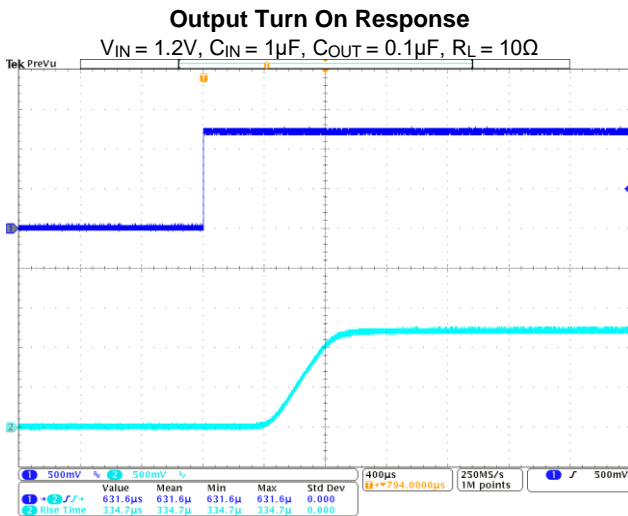
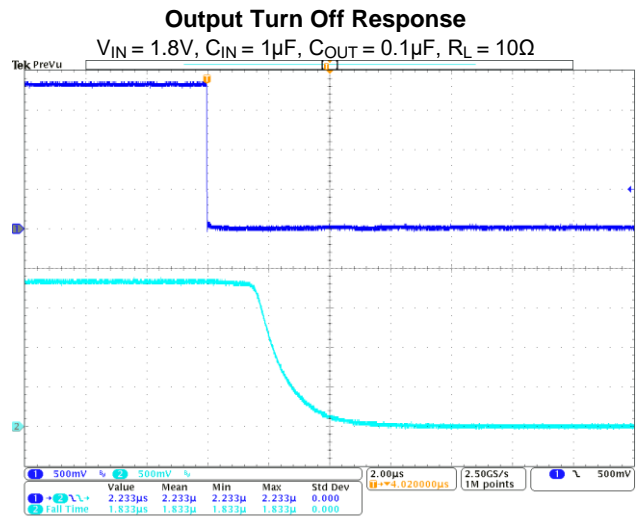
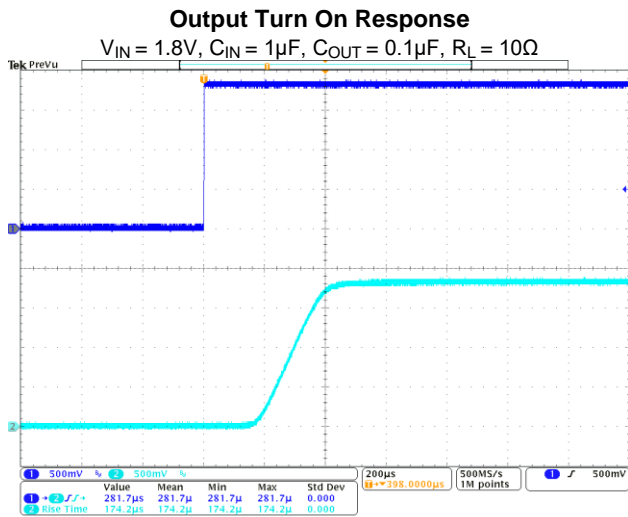

Application Information

Input Capacitor

A 1µF capacitor is recommended to connect between V_{IN} and GND pins to decouple input power supply glitch and noise. The input capacitor has no specific type or ESR (Equivalent Series Resistance) requirement. However, for higher current application, ceramic capacitors are recommended due to their capability to withstand input current surges from low impedance sources, such as batteries in portable applications. This input capacitor must be located as close as possible to the device to assure input stability and less noise. For PCB layout, a wide copper trace is required for both V_{IN} and GND.

Output Capacitor

The 0.1µF to 1µF capacitor is recommended to connect between V_{OUT} and GND pins to stabilize and accommodate load transient condition. The output capacitor has no specific type or ESR requirement. The amount of the capacitance may be increased without limit. For PCB layout, the output capacitor must be placed as close as possible to V_{OUT} and GND pins, and keep the traces as short as possible.

Enable/Shutdown Operation

The AP22908 is turned on by setting the ON pin high, and is turned off by pulling it low. To ensure proper operation, the signal source used to drive the ON pin must be able to swing above and below the specified turn-on/off voltage thresholds listed in the *Electrical Characteristics* section under V_{IL} and V_{IH} .

Discharge Operation

The AP22908 offers discharge option that helps to discharge the output charge when disabled. The discharge resistance with a typical value of 80Ω is connected between the output and ground.

Power Dissipation

The maximum IC junction temperature should be restricted to +125°C under normal operating conditions. The device power dissipation and proper sizing of the thermal plane is critical to avoid thermal shutdown and ensure reliable operation. Power dissipation of the device depends on input voltage and load conditions and can be calculated by:

$$P_D = I_{OUT}^2 \times R_{DSON} \quad (1)$$

However, the maximum power dissipation that can be handled by the device depends on the maximum junction to ambient thermal resistance, maximum ambient temperature, and maximum device junction temperature, which can be approximated by the equation below:

$$P_{D(MAX)} = \frac{(125^\circ\text{C} - T_A)}{\theta_{JA}} \quad (2)$$

Layout Guideline

Good PCB layout is important for improving the thermal performance of the device. All trace lengths should be kept as short as possible. The input (V_{IN}) and output (V_{OUT}) PCB traces should be as wide as possible to reduce stray impedance.

Use a ground plane to enhance the power dissipation capability of the device if applicable. Place input and output capacitors close to the device to minimize the effects of parasitic inductance.

Ordering Information

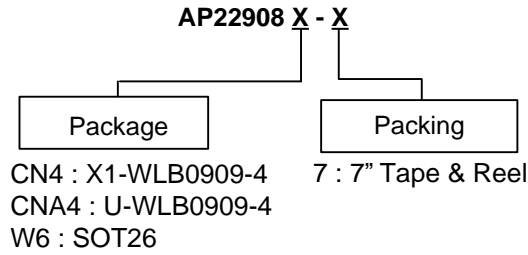

Orderable Part Number	Package Code	Package	7" Tape and Reel		
			Quantity	Carrier	Part Number Suffix
AP22908CN4-7	CN4	X1-WLB0909-4	3,000	Tape & Reel	-7
AP22908CNA4-7	CNA4	U-WLB0909-4	3,000	Tape & Reel	-7
AP22908W6-7	W6	SOT26	3,000	Tape & Reel	-7

Feature Options:

Orderable Part Number	Rise Time (Typ) at 3.6V	Output Discharge	Enable
AP22908CN4-7	105µs	Yes	Active High
AP22908CNA4-7	105µs	Yes	Active High
AP22908W6-7	105µs	Yes	Active High

Marking Information

(1) X1-WLB0909-4

(Top View)

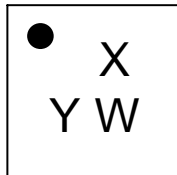

X : Identification Code
 Y : Year : 0~9
 W : Week : A~Z : 1~26 week;
 a~z : 27~52 week; z represents
 52 and 53 week

Part Number	Package	Identification Code
AP22908CN4-7	X1-WLB0909-4	4

(2) U-WLB0909-4

(Top View)

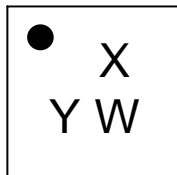

X : Identification Code
 Y : Year : 0~9
 W : Week : A~Z : 1~26 week;
 a~z : 27~52 week; z represents
 52 and 53 week

Part Number	Package	Identification Code
AP22908CNA4-7	U-WLB0909-4	8

(3) SOT26

(Top View)

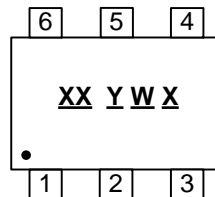

XX : Identification Code
Y : Year 0~9
W : Week : A~Z : 1~26 week;
 a~z : 27~52 week; z represents
 52 and 53 week
X : Internal Code

Part Number	Package	Identification Code
AP22908W6-7	SOT26	N8

Package Outline Dimensions

Please see <http://www.diodes.com/package-outlines.html> for the latest version.

(1) Package Type: X1-WLB0909-4

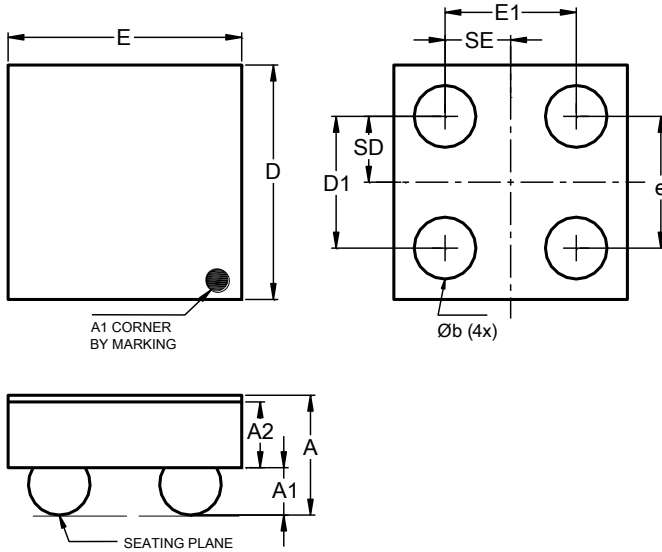

X1-WLB0909-4			
Dim	Min	Max	Typ
A	0.410	0.500	0.455
A1	0.160	0.200	0.180
A2	0.225	0.275	0.250
b	0.215	0.255	0.235
D	0.840	0.900	0.870
D1	0.450	0.550	0.500
E	0.840	0.900	0.870
E1	0.450	0.550	0.500
e	0.500 BSC		
SD	0.250 BSC		
SE	0.250 BSC		
All Dimensions in mm			

(2) Package Type: U-WLB0909-4

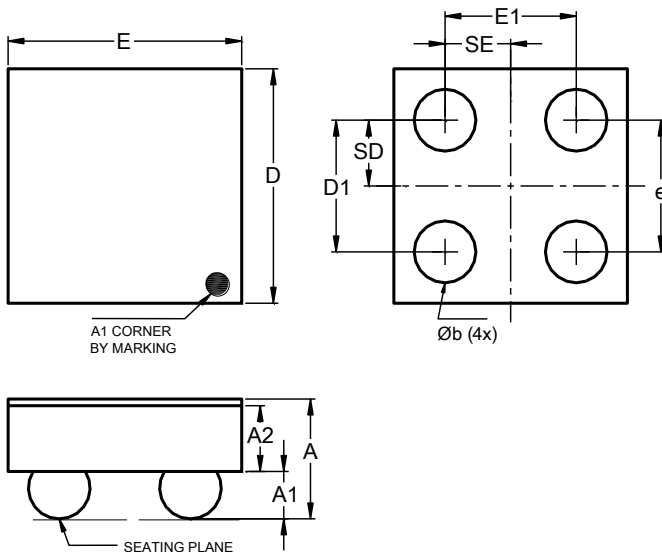

U-WLB0909-4			
Dim	Min	Max	Typ
A	0.540	0.630	0.585
A1	0.160	0.200	0.180
A2	0.355	0.405	0.380
b	0.205	0.265	0.235
D	0.860	0.920	0.880
D1	0.450	0.550	0.500
E	0.860	0.920	0.880
E1	0.450	0.550	0.500
e	0.500 BSC		
SD	0.250 BSC		
SE	0.250 BSC		
All Dimensions in mm			

Package Outline Dimensions (continued)

Please see <http://www.diodes.com/package-outlines.html> for the latest version.

(3) Package Type: SOT26

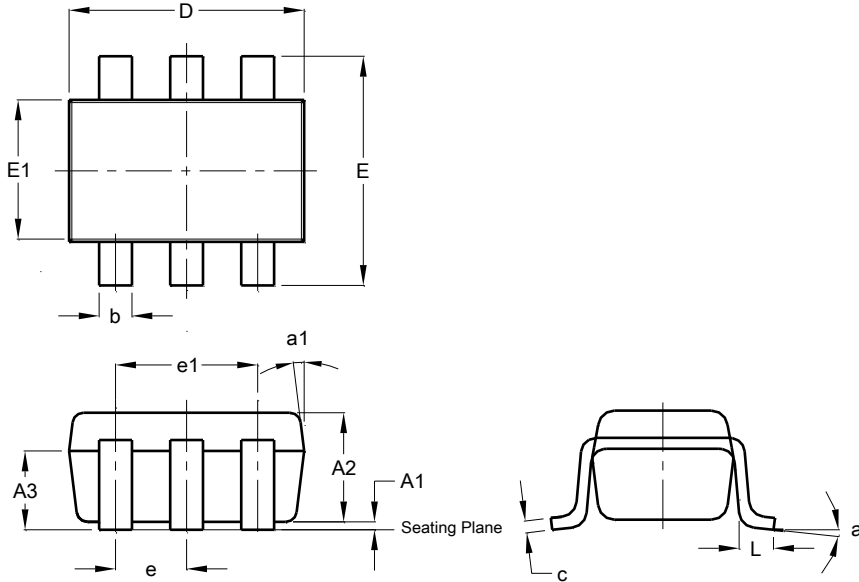

SOT26			
Dim	Min	Max	Typ
A1	0.013	0.10	0.05
A2	1.00	1.30	1.10
A3	0.70	0.80	0.75
b	0.35	0.50	0.38
c	0.10	0.20	0.15
D	2.90	3.10	3.00
e	-	-	0.95
e1	-	-	1.90
E	2.70	3.00	2.80
E1	1.50	1.70	1.60
L	0.35	0.55	0.40
a	-	-	8°
a1	-	-	7°
All Dimensions in mm			

Suggested Pad Layout

Please see <http://www.diodes.com/package-outlines.html> for the latest version.

(1) Package Type: X1-WLB0909-4 & U-WLB0909-4

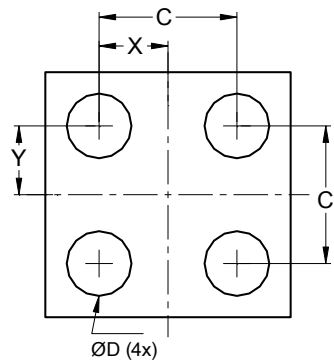

Dimensions	Value (in mm)
C	0.500
D	0.235
X	0.250
Y	0.250

(2) Package Type: SOT26

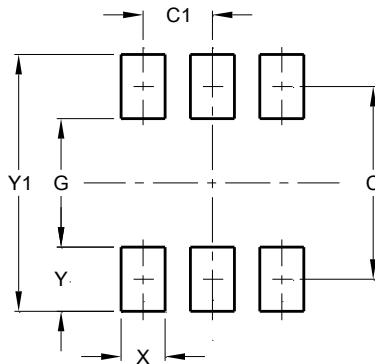

Dimensions	Value (in mm)
C	2.40
C1	0.95
G	1.60
X	0.55
Y	0.80
Y1	3.20

Mechanical Data

- Moisture Sensitivity: Level 1 per J-STD-020
- Terminals: Finish – Matte Tin Plated Leads, Solderable per MIL-STD-202, Method 208 [Ⓔ]
- Weight: 0.001 grams (Approximate)

IMPORTANT NOTICE

1. DIODES INCORPORATED (Diodes) AND ITS SUBSIDIARIES MAKE NO WARRANTY OF ANY KIND, EXPRESS OR IMPLIED, WITH REGARDS TO ANY INFORMATION CONTAINED IN THIS DOCUMENT, INCLUDING, BUT NOT LIMITED TO, THE IMPLIED WARRANTIES OF MERCHANTABILITY, FITNESS FOR A PARTICULAR PURPOSE OR NON-INFRINGEMENT OF THIRD PARTY INTELLECTUAL PROPERTY RIGHTS (AND THEIR EQUIVALENTS UNDER THE LAWS OF ANY JURISDICTION).
2. The Information contained herein is for informational purpose only and is provided only to illustrate the operation of Diodes' products described herein and application examples. Diodes does not assume any liability arising out of the application or use of this document or any product described herein. This document is intended for skilled and technically trained engineering customers and users who design with Diodes' products. Diodes' products may be used to facilitate safety-related applications; however, in all instances customers and users are responsible for (a) selecting the appropriate Diodes products for their applications, (b) evaluating the suitability of Diodes' products for their intended applications, (c) ensuring their applications, which incorporate Diodes' products, comply the applicable legal and regulatory requirements as well as safety and functional-safety related standards, and (d) ensuring they design with appropriate safeguards (including testing, validation, quality control techniques, redundancy, malfunction prevention, and appropriate treatment for aging degradation) to minimize the risks associated with their applications.
3. Diodes assumes no liability for any application-related information, support, assistance or feedback that may be provided by Diodes from time to time. Any customer or user of this document or products described herein will assume all risks and liabilities associated with such use, and will hold Diodes and all companies whose products are represented herein or on Diodes' websites, harmless against all damages and liabilities.
4. Products described herein may be covered by one or more United States, international or foreign patents and pending patent applications. Product names and markings noted herein may also be covered by one or more United States, international or foreign trademarks and trademark applications. Diodes does not convey any license under any of its intellectual property rights or the rights of any third parties (including third parties whose products and services may be described in this document or on Diodes' website) under this document.
5. Diodes' products are provided subject to Diodes' Standard Terms and Conditions of Sale (<https://www.diodes.com/about/company/terms-and-conditions/terms-and-conditions-of-sales/>) or other applicable terms. This document does not alter or expand the applicable warranties provided by Diodes. Diodes does not warrant or accept any liability whatsoever in respect of any products purchased through unauthorized sales channel.
6. Diodes' products and technology may not be used for or incorporated into any products or systems whose manufacture, use or sale is prohibited under any applicable laws and regulations. Should customers or users use Diodes' products in contravention of any applicable laws or regulations, or for any unintended or unauthorized application, customers and users will (a) be solely responsible for any damages, losses or penalties arising in connection therewith or as a result thereof, and (b) indemnify and hold Diodes and its representatives and agents harmless against any and all claims, damages, expenses, and attorney fees arising out of, directly or indirectly, any claim relating to any noncompliance with the applicable laws and regulations, as well as any unintended or unauthorized application.
7. While efforts have been made to ensure the information contained in this document is accurate, complete and current, it may contain technical inaccuracies, omissions and typographical errors. Diodes does not warrant that information contained in this document is error-free and Diodes is under no obligation to update or otherwise correct this information. Notwithstanding the foregoing, Diodes reserves the right to make modifications, enhancements, improvements, corrections or other changes without further notice to this document and any product described herein. This document is written in English but may be translated into multiple languages for reference. Only the English version of this document is the final and determinative format released by Diodes.
8. Any unauthorized copying, modification, distribution, transmission, display or other use of this document (or any portion hereof) is prohibited. Diodes assumes no responsibility for any losses incurred by the customers or users or any third parties arising from any such unauthorized use.
9. This Notice may be periodically updated with the most recent version available at <https://www.diodes.com/about/company/terms-and-conditions/important-notice>

The Diodes logo is a registered trademark of Diodes Incorporated in the United States and other countries.
DIODES is a trademark of Diodes Incorporated in the United States and other countries.
All other trademarks are the property of their respective owners.
© 2023 Diodes Incorporated. All Rights Reserved.

www.diodes.com